



compagnie
VOIX

immersive dance in mixed reality



EVE 3.0

New Creation



Eve is our ***nexus***
to ***the world of others***

EVE
3.0



CONCEPT

CONCEPT





Eve 3.0, an extension of the XR performance *Eve, dance is an unplaceable place*, is an immersive project which combines choreography and virtual reality, built on the idea of incarnation of virtual bodies in interaction with a real and physical performance.

It is based on a principle of engagement of a spectator in VR by the body that we have already experimented which and that, we want to develop further.

The experience explores common and widespread personality disorders. It questions the recurrent causes, and underlines the process of encouragement that body engagement, dialogue and sharing can generate.

The form of the experience and its integration of several levels are intended to highlight this process of encouragement.

Viewers in VR will have an intimate but limited view, a single story, and viewers outside will have a more comprehensive view of the issues. Those in VR will feel the power of interaction with an outsider. Those on the outside will see the process of mutual support and engagement of all. The subject matter and the form given to the performance converge toward the same objective: to engage the participants and the observing audience in a moment where virtual and real worlds become one.

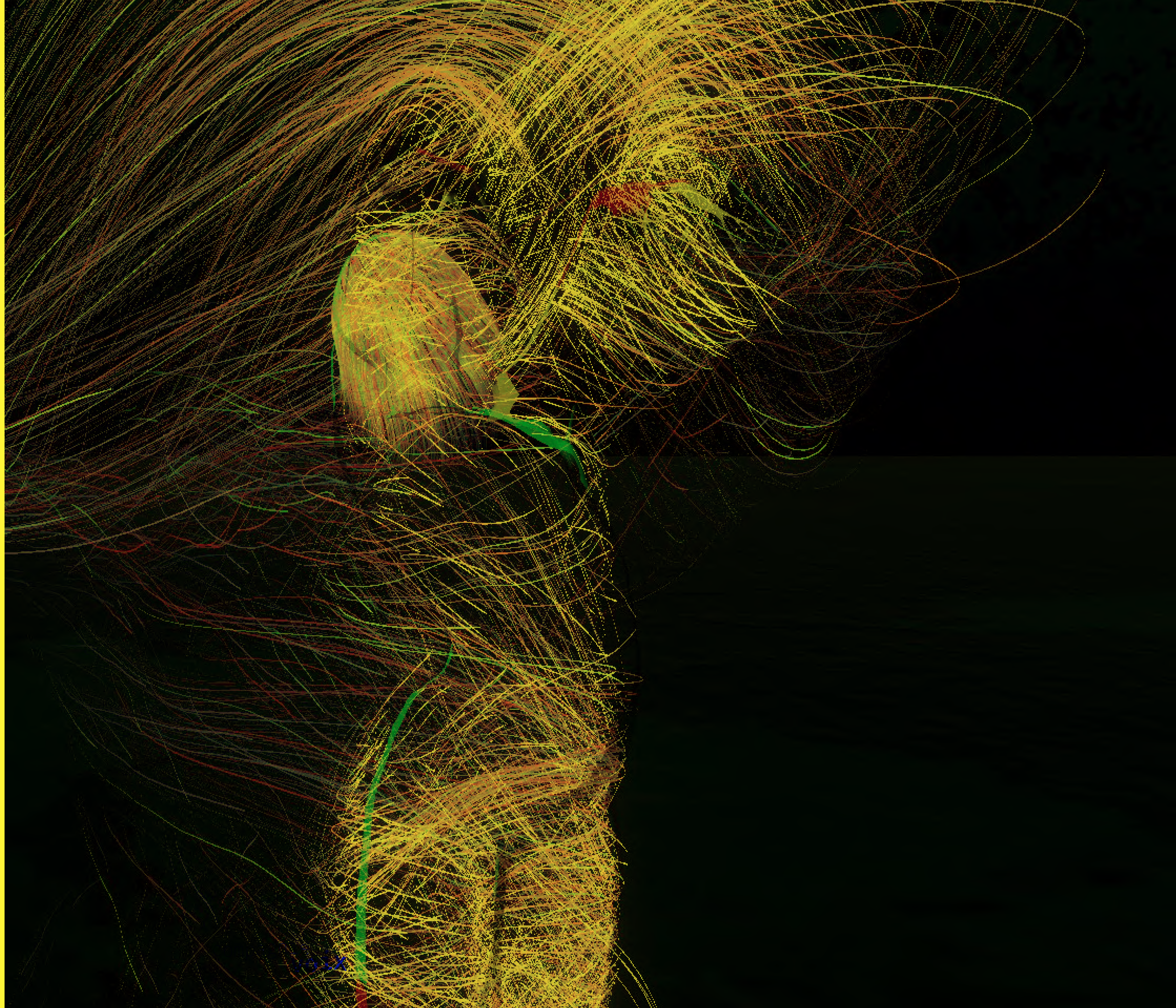

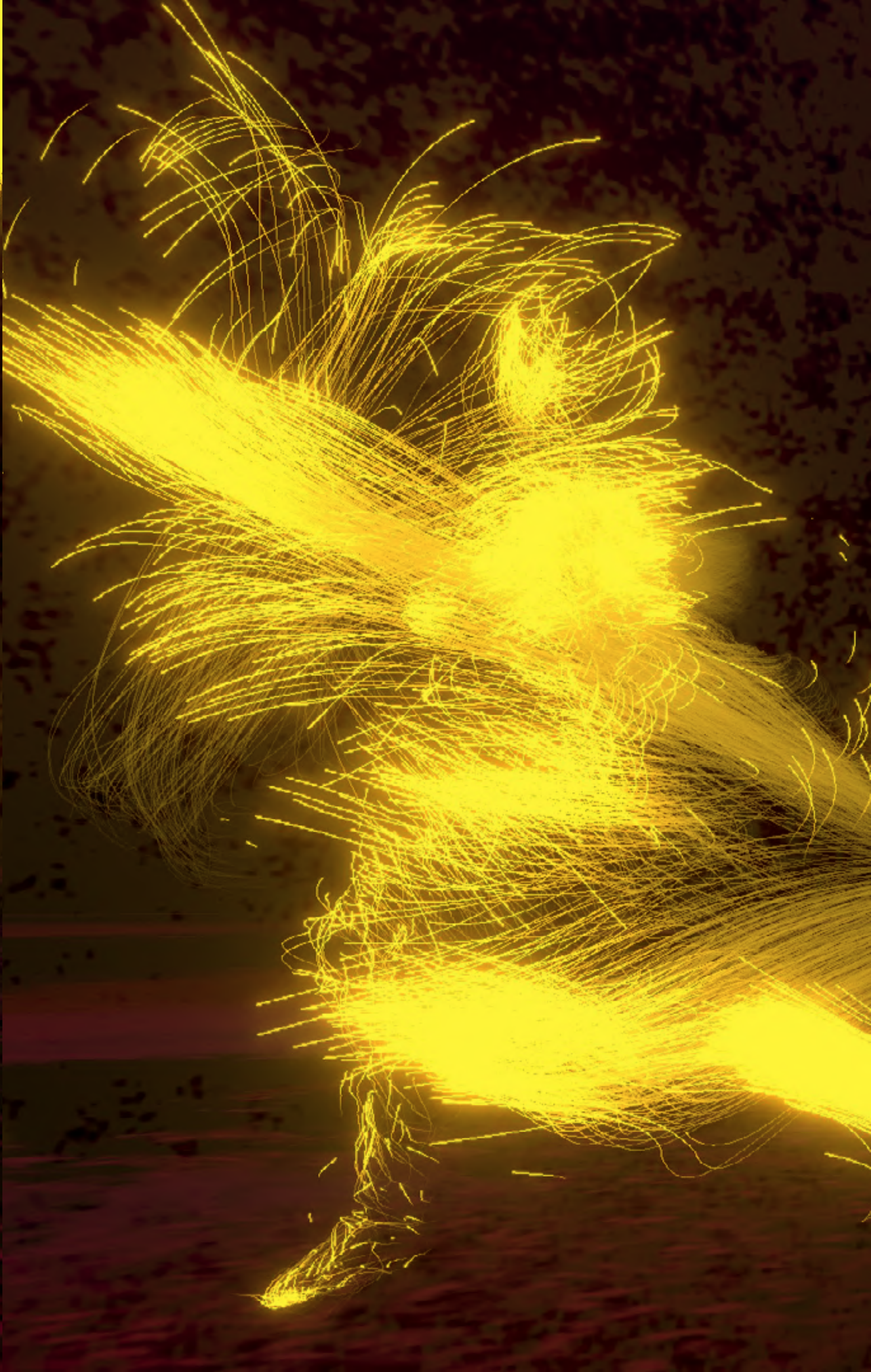

SYNOPSIS

SYNOPSIS



Eve reinterprets six emotions on stage through dance, six extreme states of consciousness: **addiction, anxiety, depression, obsession, jealousy and paranoia.**

Through her choreography, she identifies each of these extreme states. Then she seats a spectator on one of the six chairs distributed in a circle over the scenic space, which each corresponds to a state.

Six spectators then embody Eve in VR, sitting on a bench in a park. A bell rings and a group of teenagers arrive. They start playing and dancing, dragging Eve/the spectator into their dance. One of the teenagers stands a little aside. The others heckle them, playing at stealing a precious red notebook, their diary. Finally, Eve gets the diary back, and the story of this character opens up to us in voice-over, as we are plunged into a new, more dreamlike universe in animation.

The voice-over tells us moments in the lives of each of the characters where they faced their extreme state of consciousness and were dominated by their emotions. Désirée, Fiona, Meredith, Lohan, Jonas and Amir each tell us about their drama, the discovery as teenagers of the psychological dysfunction that isolates them, their powerlessness as adults, and then the encounter with a person at a time when no solution seems to exist, and the help that this person gives them. Following a voice over, a luminous silhouette performs a choreography around the spectator, ending with an outstretched hand and a liberating hug.

For the external audience, a montage of the different stories tells of the human struggle with emotions, showing each of these characters - embodied by the VR spectators - struggling and finally reaching out to the dancer who twirls from one to the other. Guided by Eve, each one will stand up, become aware of their body and its possible movements, and finally join the group.

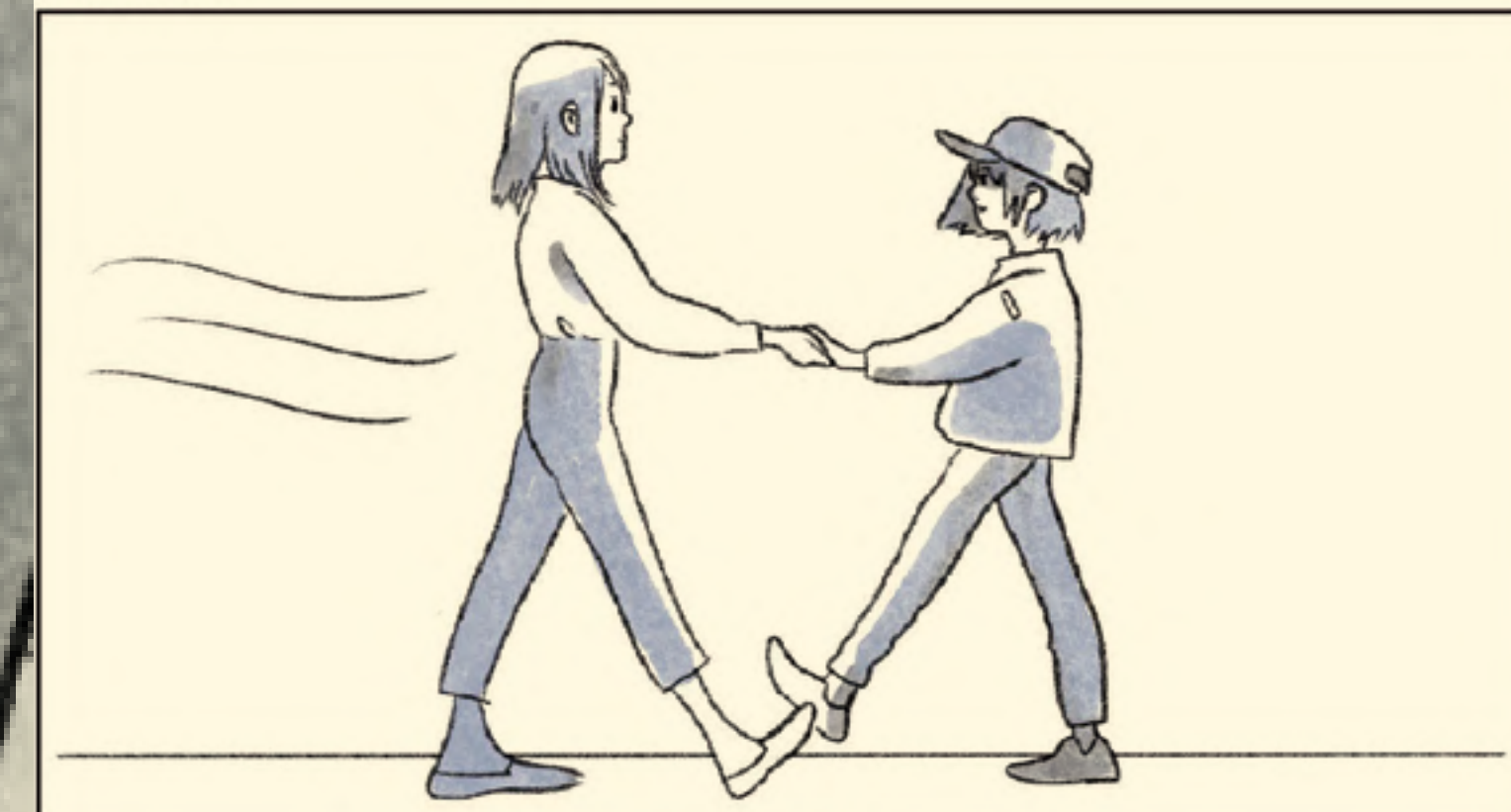
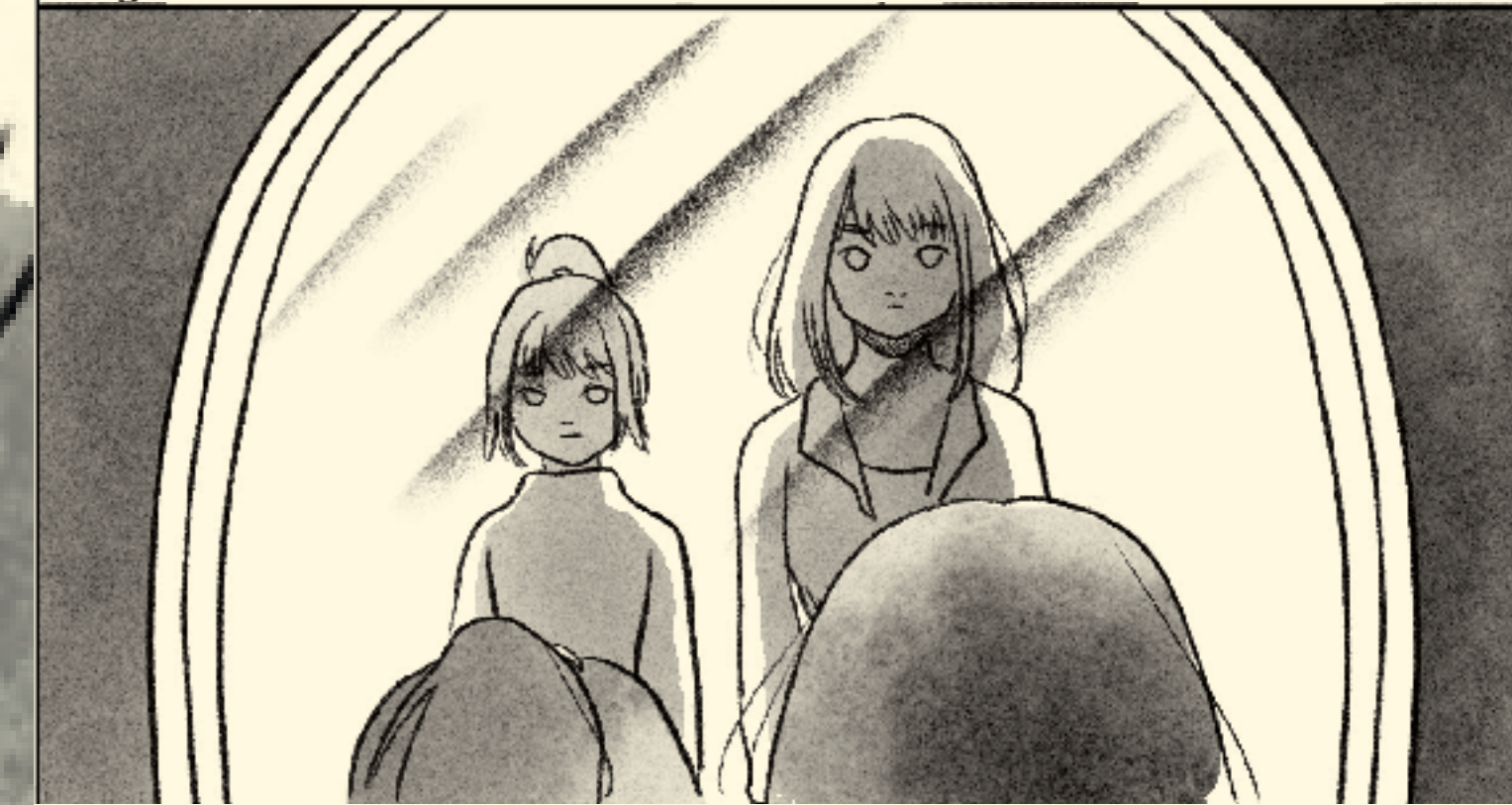
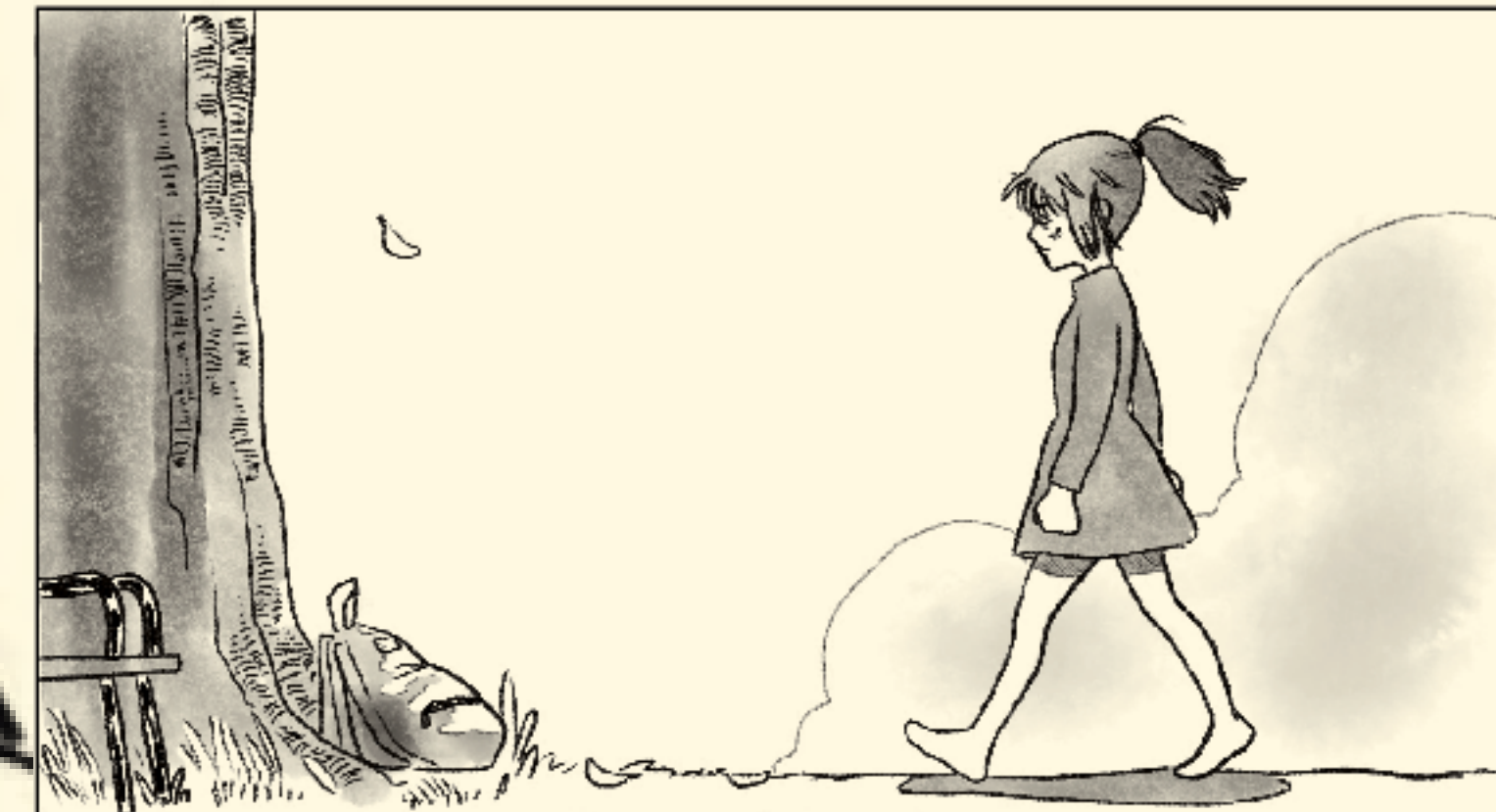

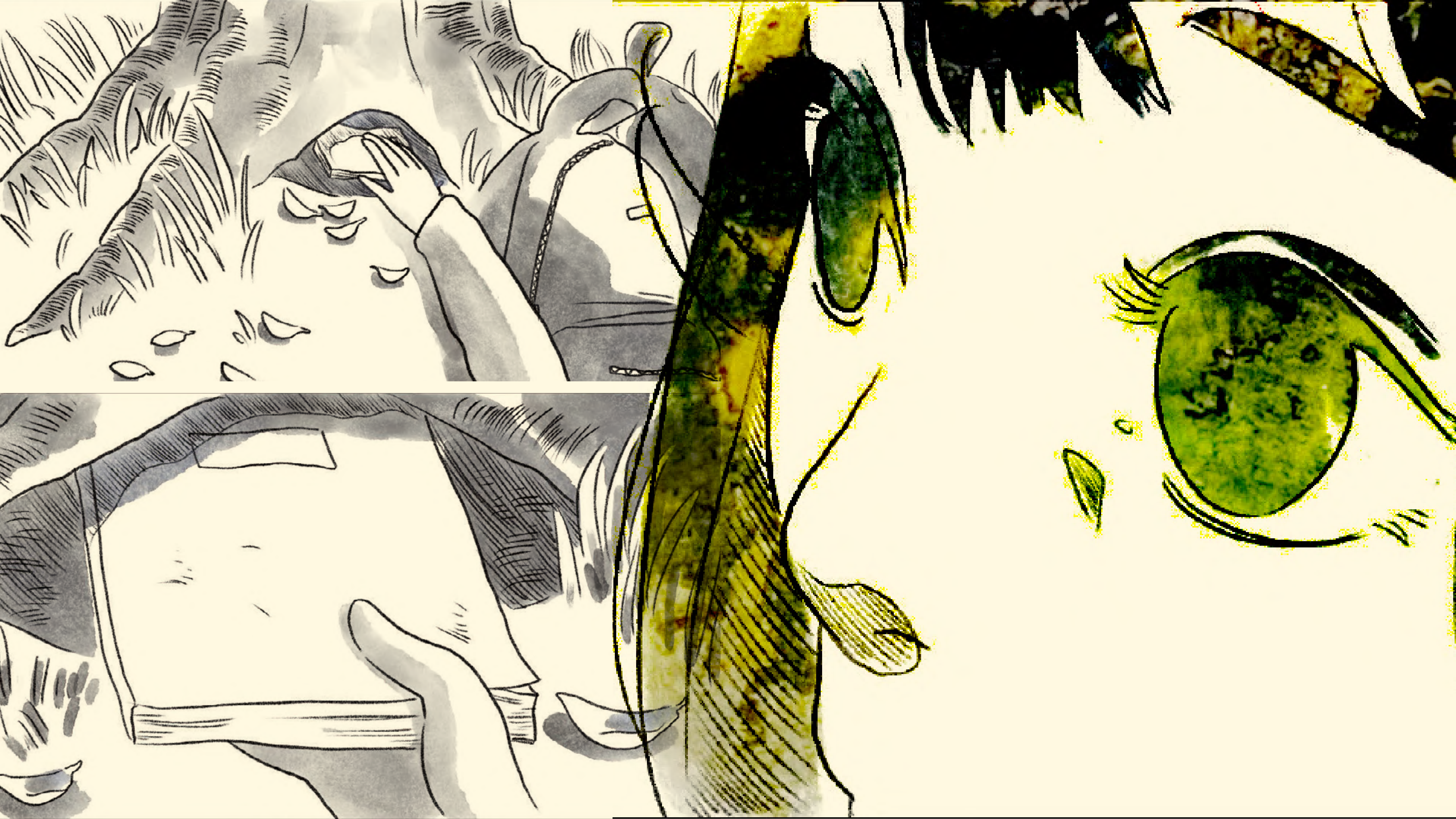



[Amir] 



[Désirée] 



[Lohan] 



[Meredith] 



[Jonas] 



[Fiona] 

SET UP

UP THE S

The experience takes place in a theater, which can accommodate approximately one hundred spectators.

In the performance space, six chairs, equipped with six virtual reality headsets, are arranged in a circle. The six chairs are the starting point of the virtual experiences, six life stories of six characters, and are identified by a visual sign consisting of a unique color and shape.

A dancer first starts a solo choreography, then she will look for six spectators in the audience to be invited to sit on the chairs and put on the headsets.

These six spectators will join a shared choreography where the dancer continues to move around them and interact with them at specific moments. For each of these spectators, these physical interactions coincide with a moment in their VR experience, and for the viewers in the room, they are part of an overall choreography.

Screens around the space relay some of what the participants see in VR to the general audience. The six VR experiences, which focus on the stories of six characters, together form a unified work.

Each VR experience leads the spectators to stand up, move, and ultimately participate freely in a shared choreography.

The first part is a live-action VR film, which includes moments of physical interaction with characters from the film, moments where the dancer interacts in real time with the spectator who is immersed in VR.

The second part is a 6dof experience where each spectator sees their avatar and can dance with a silhouette of light.

The last part allows the six spectators to see each other in the virtual space and to move together.

TECHNICAL DEVELOPMENT DIAGRAM

VR DEVELOPMENT DIAGRAM

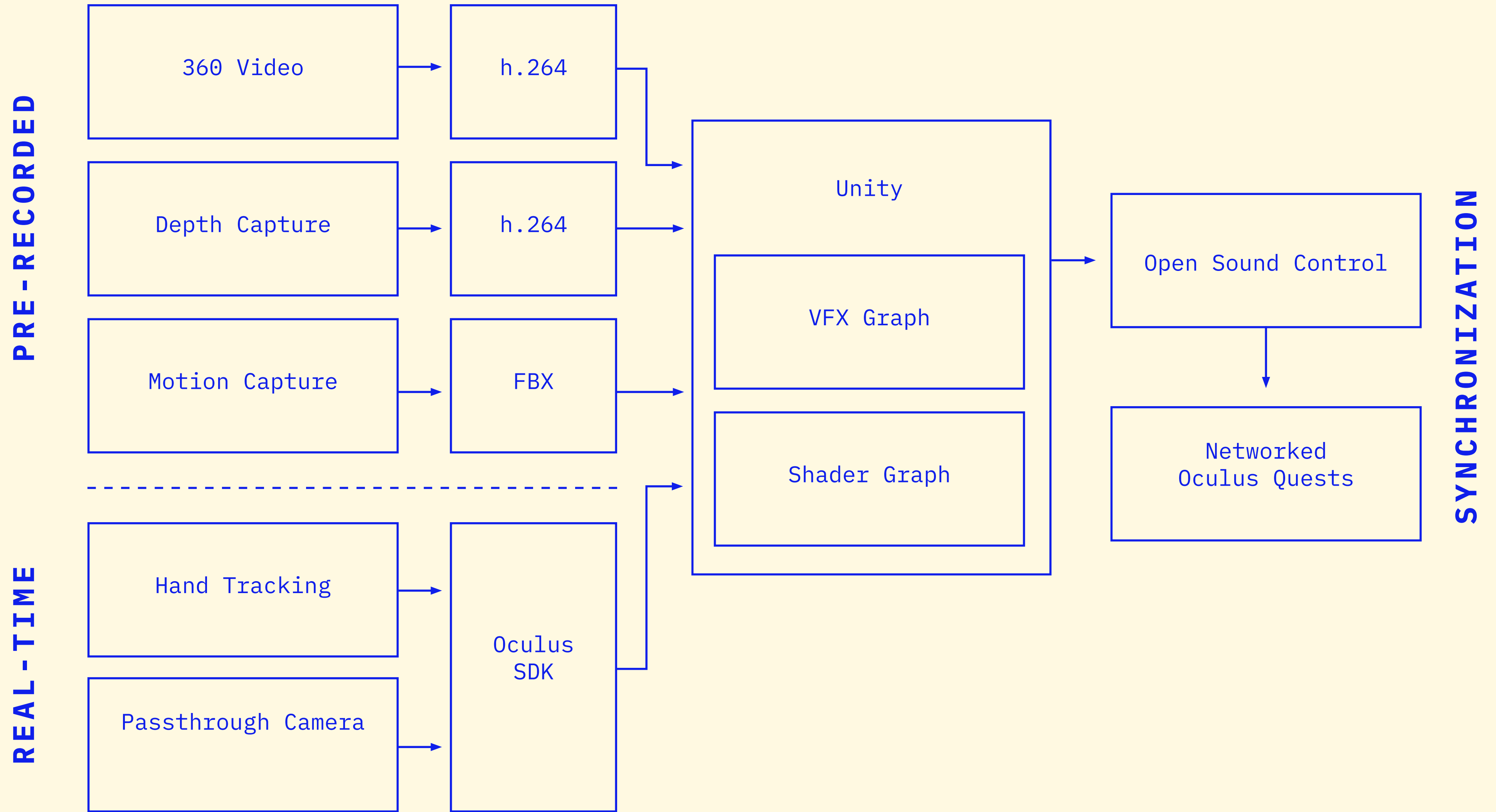

INTENTION

Body expression

is necessary to realize
a person's full communication
potential - a fundamental
element of the consciousness
we have of our own body.

Dance creates
metaphorical visions
and new ways to understand
diversity.





The subject of this artistic project is presenting social features that affect us far more than we can imagine: the protagonists deal with living conditions that are little-known but nevertheless frequently observed on a daily basis. In this context, the mental question manifests itself in the body, which then becomes its tool of representation in movement.

The body in motion
materializes
the psychology
of a person,

the cause of the sensory and social conditions in which they evolve, determined according to a broad spectrum that can affect the motor, emotional and unconscious spheres.



CURRENT TEAM & PARTNERS

CURRENT TEAM & PARTNERS

CHOREOGRAPHY AND DIRECTION:
Margherita Bergamo Meneghini

PHOTOGRAPHY AND PROOFREADING:
Audrey Planchet

SCRIPTWRITER AND CHOREOGRAPHY ASSISTANCE:
Veronica Boniotti

MUSIC COMPOSER AND SOUND DESIGNER:
Dale Nichols

SCRIPTWRITER AND ASSOCIATE PRODUCER:
Mark Lee

AUDIOVISUAL SUPPORT:
Jade Annest (Digital Rise),
Émilie Léveillé

PRODUCER:
Maria Leon Arraez

COSTUME DESIGN:
Paloma Bomé

VR INTERACTION CONCEPT:
Daniel González Franco

DANCERS:
Élise Boileau, Camille Chevalier,
Benjamin Labruyère

REAL-TIME VR DEVELOPMENT AND GRAPHIC DESIGN:
John Desnoyers-Stewart

PRODUCTION COMPANY:
Compagnie Voix

VISUAL DESIGN:
Kirstin Huber, Amira-Sade Moodie

MOTION CAPTURE:
Anastasiia Ternova,
Justine Waller (didascalie.net)

STORYBOARD:
Ari Schneider

With the support of France Active Bourgogne, FDVA, Département de Saône-et-Loire, Région Bourgogne-Franche-Comté, Château Éphémère - Fabrique sonore et numérique, Artdam Dijon, the provision of studios at CN D - Centre national de la danse Paris, and with the participation of Seesaw Project.

Supported in development by DIGITAL RISE.

Thanks to BeAnotherLab, Omnipresenz, Institut Marey I3M Université de Bourgogne Dijon, L'Atheneum Dijon, PRAST Université Rennes 2 and Le Centquatre-Paris.

[Eve 3.0] is conceived as an evolution of the previous creation "Eve, dance is an unplaceable place", produced in 2018 by Compagnie Voix and Omnipresenz.

BIOOS

Margherita Bergamo Meneghini

Margherita Bergamo Meneghini has been dedicated to contemporary dance and completed studies in Choreography in Barcelona after a professional career with the Italian rhythmic gymnastics team. Her way of representing dance seeks unconventional lines, alternative contexts and experiences, always with the participation of the audience. She worked with the dance company Erre que erre from 2005 to 2010, and she was the artistic co-director of Les filles Follen from 2010 to 2015. In 2017, she founded Compagnie Voix, and in this framework she began a research creation on dance and technological applications. Her piece "Eve, dance is an unplaceable place", co-created with Daniel González, won the Laval Virtual Award Recto VRso, the Grand Prix VR at the Kaohsiung Film Festival, and it is selected in the Catalog of the Digital Department of the Institut Français. She currently creates choreographies in 3D, VR and XR for Trizz Studio, Atelier Daruma, Digital Rise, Tamanoir and collaborates in research with various universities such as Paris 8 and University of Bologna.

Veronica Boniotti

Veronica Boniotti, philosopher, psycho-educator and choreographer, obtained her degree in Philosophy of Science at La Sapienza University in Rome, Italy, and attended classes at the University of Paris-Sorbonne in France. She then went on to complete a Master's degree in Philosophy and Cognitive Sciences at the University of Bristol in England. Over the years, she has been trained in the Feuerstein method (which questions the idea of irreversibility of development and considers that every human being has a potential for learning, a capacity for change, whether it be in their mental, emotional or behavioral functioning when mediation is provided) and also in the DIR Floortime model. She currently carries out individual and small group classes, psycho-educational interventions and integrates therapeutic practice with games and activities centered on the body and movement. Her choreographic training is a fundamental aspect of her journey, which constantly accompanies the enrichment of the quality of the relationship with children and young people she meets. She is the founder and artistic director of the Seesaw Project in Riva del Garda (Italy).

Daniel González Franco

Daniel González Franco is a digital artist born in Colombia and based in Barcelona (Spain). He obtained a Master's degree in Digital Arts at the Universitat Pompeu Fabra in Barcelona. Daniel is an interdisciplinary researcher, artist and entrepreneur. He considers himself an explorer of electronic art and a designer of interactions, with a special interest in VR, telepresence and social innovation. He is one of the founders of the BeAnotherLab collective, creators of "The Machine to Be Another", an embodied virtual

reality system that explores the relationship between identity and empathy from an embodied point of view, which received an honorary mention in the Prix Ars Electronica 2014 (Linz, Austria). He has participated in several residencies and projects at international art and new media festivals, including Tribeca Film Festival in New York, IDFA (Amsterdam), Musrara MIX (Jerusalem), Print Screen (Tel Aviv), Artport (Tel Aviv), as well as collaborations with the United Nations and a fellowship at MIT in Cambridge (USA). Daniel is also the founder of Omnipresenz, an XR creative studio based in Barcelona that focuses on embodied virtual reality, telepresence and immersive storytelling, but above all on the magic of human presence and emotion as a key factor in creativity and human connection. Along with Margherita, Daniel has received the prestigious Laval Virtual Award 2019 Recto VRso and the Grand Prix KFF in Taiwan.

**John
Desnoyers-Stewart**

John Desnoyers-Stewart is an interdisciplinary researcher/creator pursuing his PhD in Interactive Art and Technology at Simon Fraser University in Vancouver, BC, Canada. He is a professional engineer, and holds a Master of Fine Arts in Interdisciplinary Studies, and also consults with a wide range of expertise, including graphic and product design, and has developed mixed reality instruments for music. He has exhibited his multi-user mixed reality installations, Transcending Perception, Body RemiXer and JeL around Canada. Through these installations, John brings his expertise to support social connection and collaborative creativity, explore the social applications of virtual reality, better understand the experience of embodying abstract bodies, and encourage new perspectives on immersive technology.

**Mark
Lee**

Mark Lee is a writer, screenwriter, producer and filmmaker based in Brooklyn New York. He has a background in theatre, as a writer, playwright and director, and in literature - focusing on modern European literature and literary translation theory. Previously, he was producer of the feature film "Lotus Eaters" which premiered at the Tribeca Film Festival in 2011 and was released in theatres in New York, Los Angeles, London, Toronto and Montreal in 2013. He holds a B.A. in Comparative Literature from Hamilton College in New York State, and an MPhil in European Literature from Cambridge University (UK), with the thesis "The Theory and Practice of Literary Translation". He also studied film, with an MA at the London Film School, where his thesis film "tran . si . tions" won an award at the Hamptons International Film Festival. He is currently writing screenplays and stories for text-based narrative platforms, and is adapting one of his epics into a graphic novel. He recently completed a short film entitled "Stillwater", as writer and director.

**Dale
Nichols**

Dale Nichols is a Canadian composer who found his love for music at an early age, starting with the piano and expanding to other instruments as his curiosity grew. He was classically trained through the Royal Conservatory of Music of Vancouver BC and participated in music festivals and competitions, garnering awards for performances throughout his youth. For the past four years he has been based in Dubai, United Arab Emirates, collaborating with local and international filmmakers, creating the soundtracks to short films, documentaries, commercials, and virtual reality projects. He now lives in Vancouver.

**Kirstin
Huber**

Kirstin Huber is a NYC-based graphic designer and an Associate Partner at Pentagram. Her previous experience includes seven years (2010-2017) as the in-house Art Director at The Public Theater, practicing a devotion to beautiful typography and cultivating a deep love of theater and performance art. Since 2017, she has worked with various clients on branding campaigns, books, film and theater posters, music videos, projection design, and more.



Eve 3.0
[teaser]



Eve 3.0
[stories]



Eve @ VR Arles
[reportage and interview
by Fisheye]

CONTACT

Compagnie Voix contact@compagnievoix.com
compagnievoix.com
+33 6 85 08 43 83

compagnievoix.com